

Concrete cones and concrete adhesives

Tie points

Instructions for Assembly and Use – Standard Configuration – Issue 11/2020

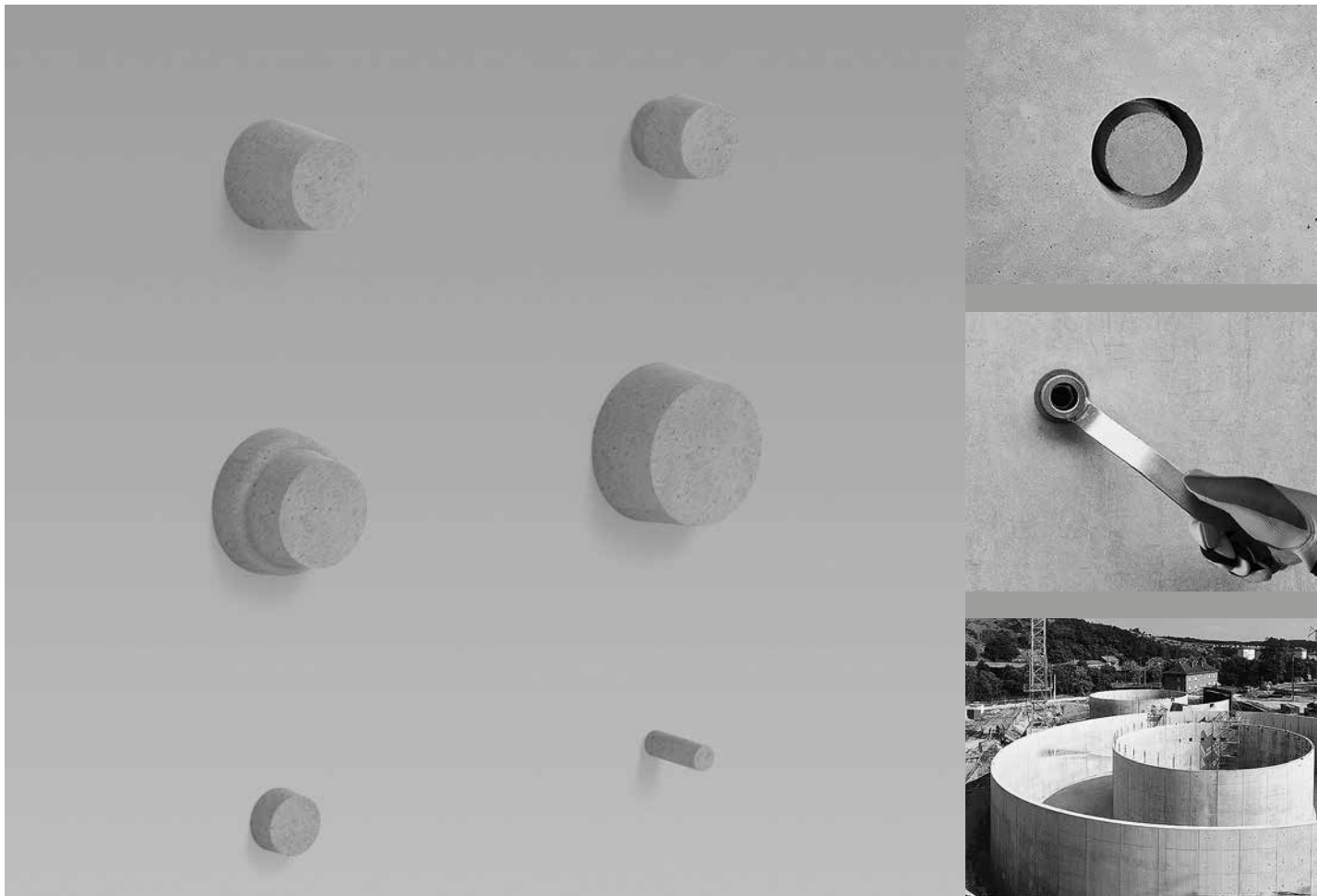

Overview	
System components	3
– Concrete cones	3
– Sealing Compound-3	5
– Repoxal adhesive	5
Introduction	
Key	6
Target groups	7
Additional documentation	7
Intended use	8
Instructions for Use	8
Safety instructions	
Cross-system	9
System-specific	11
DK and SK Concrete Cones	
Installing DK and SK Concrete Cones	12
– Removing tie cones	12
– Tool for removing tie cones	12
– Concrete adhesive	13
– Installing concrete cones	13
– Tongs for installing concrete cones	13
SK Lead Cone	
Installing the SK Lead Cone	15
KK and SWLK Concrete Cones	
Installing KK and SWLK Concrete Cones	16
– Removing tie cones	16
– Tool for removing climbing cones	16
– Concrete adhesive	17
Plug FRC	
Installing Plugs FRC	18
– Concrete adhesive	18
Plug FC MX	
Closing the tie hole	20
– Concrete adhesive	20
Plug FCP 22	
Closing the tie hole	22
– Concrete adhesive	22
Programme overview	
Concrete cones and concrete adhesives	24

System components

Concrete cones							
Image	Item no.	Pos.	Designation	Concrete adhesive	Consumption of adhesive per cone	Number of cones per kg of adhesive	
	031642	55.1	DK Concrete Cone DW 15-58/30	Repxal adhesive Item no. 031550 – for recessed installation	~ 24 g	~ 41 pcs	
				Sealing Compound-3 Item. no. 131709 – for flush-mounted installation ¹⁾	~ 27 g	~ 37 pcs	
	031643	55.2	DK Concrete Cone UNI 58/52 ^{1), 2), 3), 4)}	Sealing Compound-3 Item no. 131709	~ 34 g	~ 29 pcs	
	132972	55.3	DK Concrete Cone Architectural 02 UNI 58/52	Sealing Compound-3 Item no. 131709	~ 24 g	~ 41 pcs	
	031650	55.4	SK Concrete Cone DW 20-67/60 ¹⁾	Sealing Compound-3 Item no. 131709	~ 45 g	~ 22 pcs	
	031651	55.5	SK Concrete Cone DW 26-100/60	Sealing Compound-3 Item no. 131709	~ 76 g	~ 13 pcs	
	104643	61	SK Lead Cone DW 15 ⁵⁾	Install without adhesive.	–	–	
	031652	64.1	KK Concrete Cone M 24-67/52	Sealing Compound-3 Item no. 131709	~ 33 g	~ 30 pcs	
	031653	64.2	KK Concrete Cone M 30-80/52	Sealing Compound-3 Item no. 131709	~ 43 g	~ 23 pcs	
	031654	64.3	KK Concrete Cone M 36-90/52	Sealing Compound-3 Item no. 131709	~ 57 g	~ 17 pcs	
	136576	64.4	SWLK Concrete Cone M36-105/52	Sealing Compound-3 Item no. 131709	~ 84 g	~ 12 pcs	

Applications			
Item no.	Pos	Shuttering components	
031635 031639 112937 127425	51.1 50.1 51.8 51.9	DK Sealing Cone DW 15/35 SK Sealing Cover UNI DW 15 Magnet Cone MX 15 Magnet Cone MX 18	
031636 031639	51.2 50.1	DK Sealing Cone DW 15/55 SK Sealing Cover UNI DW 15	
126609 031639	51.5 50.1	SK Tie Cone-2 DW 15 SK Sealing Cover UNI DW 15	
031637	51.3	DK Sealing Cone DW 20/55	
031638	51.4	DK Sealing Cone DW 26/55	
112937	51.8	Magnet Cone MX 15	
127425	51.9	Magnet Cone MX 18	
031636 031639	51.2 50.1	DK Sealing Cone DW 15/55 SK Sealing Cover UNI DW 15	
126609 031639	51.5 50.1	SK Tie Cone-2 DW 15 SK Sealing Cover UNI DW 15	
031637	51.3	DK Sealing Cone DW 20/55	
031638	51.4	DK Sealing Cone DW 26/55	
112937	51.8	Magnet Cone MX 15	
127425	51.9	Magnet Cone MX 18	
031646 031648	51.6 50.2	SK Tie Cone DW 20 SK Sealing Cover DW 20	
031647 031649	51.7 50.3	SK Tie Cone DW 26 SK Sealing Cover DW 26	
126609	51.5	SK Tie Cone-2 DW 15	
031220	62.2	Climbing Cone-2 M24/DW 15	
114158	62.1	Screw-On Cone-2 M24/DW 20	
029480		Suspension ring M30	
029490		Suspension ring M36	
029480		Suspension ring M30	
029490		Suspension ring M36	
126609	51.5	SK Tie Cone-2 DW 15	
031646	51.6	SK Tie Cone DW 20	
031647	51.7	SK Tie Cone DW 26	
128536	62.4	Heavy-Duty Cone M 36 / DW 26 - D108	

Concrete cones				
Image	Item no.	Pos.	Designation	
	116234	67.2	Plug FRC Ø 32	
	123820	67.3	Plug FRC Ø 40	
	126699	72	Plug FC MX 15 1/50 ⁴⁾	
	126700	73	Plug FC MX 15 2/50 ⁴⁾	
	136737	74	Plug FC MX 18 3/50 ⁴⁾	
	136738	75	Plug FC MX 18 4/50 ⁴⁾	
	031360	76	Plug FCP 22	

¹⁾ sound-absorbing

²⁾ suitable for drinking water

³⁾ fire resistant F90

⁴⁾ impermeable to water

⁵⁾ radiation-resistant, install in addition to SK Concrete Cone DW 15

				Applications	
	Concrete adhesive	Consumption of adhesive per cone	Number of cones per kg of adhesive	Item no.	Shuttering components
	Repoxal adhesive Item no. 031550	~ 9 g	~ 108 pcs	026230 116233 115150	Tie Sleeve M24 Cone FRC D32/52 Anchor Positioning Stud M24x65
	Repoxal adhesive Item no. 031550	~ 12 g	~ 83 pcs	026230 123800 129157	Tie Sleeve M24 Threaded Cone M24/40 Wire nail 4.6x130
	Repoxal adhesive Item no. 031550	~ 8 g	~ 122 pcs	113847 112387 112464	Tie MX 15, 15 – 25 Tie MX 15, 20 – 30 Tie MX 15, 30 – 40
	Repoxal adhesive Item no. 031550	~ 9 g	~ 107 pcs		
	Repoxal adhesive Item no. 031550	~ 11 g	~ 88 pcs	123901 123902 123903 123904 123905	Tie MX 18, 15 – 25 Tie MX 18, 20 – 30 Tie MX 18, 30 – 40 Tie MX 18, 40 – 50 Tie MX 18, 50 – 60
	Repoxal adhesive Item no. 031550	~ 13 g	~ 76 pcs		
	Repoxal adhesive Item no. 031550	~ 5 g	~ 183 pcs		
	Repoxal adhesive Item no. 031550	~ 5 g	~ 183 pcs	065033 031260 031390	Cone DR 22 and Fibre Cement Pipe FCP 22 Cone FCP 22

Sealing Compound-3

2 components

Item no. 131709 – set of tins, 6 tins each component A + 6 tins each component B. Also available in tins as single components:

- Item no. 131710, Sealing Compound-3, tin KO-A
- Item no. 131711, Sealing Compound-3, tin KO-B

Sealing Compound-3 ensures an all-round uniform sealing joint when installing concrete cones. This ensures that the concrete cone is centred. At the same time, it prevents the concrete cone from settling. (Fig. 01)



Fig. 01

Repoxal adhesive

2 components

Item no. 031550













Clearance < 1.5 mm

The Repoxal adhesive



- joins the concrete cone to the adhesive by means of a thin layer – thin-layer adhesive joint.
- is viscous.

Key

Pictogram | Definition

-  Danger / Warning / Caution
-  Note
-  To be complied with
-  Load-bearing point
-  Visual inspection
-  Tip
-  Incorrect use
-  Safety helmet
-  Safety shoes
-  Safety gloves
-  Safety goggles
-  Personal protective equipment to prevent falling from a height (PPE)

Arrows

-  Arrow representing an action
-  Arrow representing a reaction of an action
-  Arrow representing forces

Safety instruction categories

The safety instructions alert site personnel to the risks involved and provide information on how to avoid these risks. Safety instructions are featured at the beginning of the section or ahead of the instructions, and are highlighted as follows:

Danger

This sign indicates an extremely hazardous situation which, if not avoided, will result in death or serious, irreversible injury.

Warning

This sign indicates a hazardous situation which, if not avoided, could result in death or serious, irreversible injury.

Caution

This sign indicates a hazardous situation which, if not avoided, could result in minor or moderate injury.

Note

This sign indicates situations in which failure to observe the information can result in material damage.

Format of the safety instructions

Signal word

Type and source of hazard!
Consequences of non-compliance.
Preventative measures.

Dimensions

Dimensions are usually given in cm. Other measurement units, e.g. m, are shown in the illustrations.

Conventions

- Instructions are numbered with: 1., 2., 3.
- The result of an instruction is shown by: →
- Position numbers are clearly provided for the individual components and are given
 - in the drawing, e.g. 1,
 - in brackets in the text, e.g. (1).
- Multiple position numbers, i.e. alternative components, are represented with a slash: e.g. 1 / 2.

Terminology

The following terms have been renamed to make them easier to read and understand:

- "DK Sealing Cone or SK Tie Cone" in the headings or instructions to "cones".
- "Sealing Compound-3" or "Repoxal adhesive" to "adhesive".

Notes on illustrations

The illustration on the front cover of these instructions is understood to be a system representation only. The assembly steps presented in these Instructions for Assembly and Use are shown in the form of examples with only one component size. They are valid for all component sizes contained in the standard configuration.

To facilitate understanding, detailed illustrations are sometimes incomplete. The safety installations which have possibly not been shown in these detailed illustrations must nevertheless be available.

Target groups

Contractors

These Instructions for Assembly and Use are designed for contractors who

- assemble, modify and dismantle the scaffolding, or
- use them, e.g. for concreting, or
- allow them to be used, e.g. for forming operations.

Competent person

(Construction Site Coordinator)

The Safety and Health Protection Coordinator*

- is appointed by the client,
- must identify potential hazards during the planning phase,
- determines measures that provide protection against risks,
- creates a safety and health protection plan,
- coordinates the protective measures for the contractor and site personnel so that they do not endanger each other,
- monitors compliance with the protective measures.

Competent persons qualified to carry out inspections

Due to the specialist knowledge gained from professional training, work experience and recent professional activity, the competent person qualified to carry out inspections has a reliable understanding of safety-related issues and can carry out inspections correctly. Depending on the complexity of the inspection to be undertaken, e.g. scope of testing, type of testing or the use of certain measuring devices, a range of specialist knowledge is necessary.

Qualified personnel

The scaffolding may only be assembled, modified or dismantled by personnel who are suitably qualified to do so. Qualified personnel must have completed a course of training** in the work to be performed, covering the following points at least:

- Explanation of the plan for the assembly, modification or dismantling of the scaffolding in an understandable form and language.
- Description of the measures for safely assembling, modifying or dismantling the scaffolding.
- Naming of the preventive measures to be taken to avoid the risk of persons and objects falling.

- Designation of the safety precautions in the event of changing weather conditions that could adversely affect the safety of the scaffolding, as well as the personnel concerned.
- Details regarding permissible loads.
- Description of all other risks and dangers associated with assembly, modification or dismantling operations.



- **In other countries, ensure that the relevant national guidelines and regulations in the respective current version are complied with!**
- **If no country-specific regulations are available, it is recommended to proceed according to German guidelines and regulations.**
- **A competent person must be present on site during scaffolding operations.**

* Valid in Germany: Regulations for Occupational Health and Safety on Construction Sites 30 (RAB 30)

** Instructions are given by the contractor themselves or a competent person selected by them.

Additional documentation

- Safety data sheets of concrete adhesives

Intended use

Product description

PERI products have been designed for exclusive use in the industrial and commercial sectors only by suitably trained personnel.

Concrete cones

Concrete cones have a

- smooth, non-porous surface
- grey concrete colour
- an average hardness strength of 100 N/mm²
- certified water permeability in accordance with DIN 1048, Section 5 (corresponds to 50 m head of water)

Depending on the application, different PERI tie systems and thus different groups of concrete cones can be used. For an overview of the concrete cones, see table "System components" on page 3.

PERI tie systems* SK and DK are

- waterproof
DIN EN 12390-8:2019
(item no. 126699 + 126700)
- gas impermeable
- fire resistant F90
- sound-absorbing

DK Cones DW 15, 20, 26 have the same external shape, i.e. the concrete cone fits into all cone openings.

* always take the overall system and all its framework conditions into account.

Concrete adhesive

There are two different types of concrete adhesive. These are:

- Sealing Compound-3
- Repoxal adhesive

Sealing Compound-3

Sealing Compound-3

- is a 2-component adhesive
- has a grey concrete colour
- has a processing time of approx. 1 hour at 23 °C
- has a density of 1.70 g/cm³
- is resistant to salt water
- is cold and heat-resistant
- is acid resistant to a limited extent
- is suitable for:
 - drinking water tanks
 - containers for foodstuffs according to KTW (German Drinking Water Standard) and DVGW (German Technical and Scientific Association for Gas and Water) recommendations
- ensures an all-round uniform sealing joint when installing concrete cones by means of an granular additive with particles of a suitable size for the gap.
This ensures that the concrete cone is centred and prevents the concrete cone from settling.

Repoal adhesive

The Repoxal adhesive

- is a 2-component adhesive
- has a light grey colour
- has a density of 1.54 g/cm³

Instructions for Use

Use in a way not intended, deviating from the standard configuration or the intended use according to the Instructions for Assembly and Use, represents a misapplication with a potential safety risk, e.g. risk of falling.

Only PERI original components may be used. The use of other products and spare parts is not allowed.

Changes to PERI components are not permitted.

The system described in these Instructions for Assembly and Use may contain patent-protected components.

Cross-system



Safety instructions apply to all service life phases of the system.

General

The contractor must ensure that the Instructions for Assembly and Use supplied by PERI are available at all times and understood by the site personnel.

These Instructions for Assembly and Use can be used as the basis for creating a risk assessment. The risk assessment is compiled by the contractor. However, these Instructions for Assembly and Use do not replace the risk assessment!

Refer to and comply with the safety instructions and permissible loads.

For the application and inspection of PERI products, the current safety regulations and guidelines valid in the respective countries must be observed.

Materials and working areas are to be inspected before each use and assembly, for:

- damage,
- stability and
- functional correctness.

Damaged components must be exchanged immediately on site and may no longer be used.

Safety components are to be removed only when they are no longer required.

When on slab formwork, scaffolds and working platforms:

- do not jump,
- do not run,
- do not drop anything from or onto it.

Components provided by the contractor must comply with the characteristics stipulated in these Instructions for Assembly and Use and all applicable laws and standards.

Unless otherwise indicated, the following applies in particular:

- timber components: strength class C24 for solid wood according to EN 338.
- scaffold tubes: galvanised steel tubing with minimum dimensions $\text{Ø } 48.3 \times 3.2 \text{ mm}$ according to EN 12811-1:2003 4.2.1.2.
- scaffold tube couplings according to EN 74-1 and EN 74-2.

Deviations from the standard configuration are only permitted after a further risk assessment has been carried out by the contractor.

Appropriate measures for working and operational safety, as well as stability, are defined on the basis of this risk assessment.

Corresponding proof of stability can be provided by PERI on request, if the risk assessment and resulting measures to be implemented are made available.

Before and after exceptional occurrences that may have an adverse effect on the safety of the formwork system, the contractor must immediately

- produce another risk assessment and make use of its results to take suitable steps to guarantee the stability of the formwork system,
- arrange for an extraordinary inspection to be carried out by a competent person qualified to do so. The aim of this inspection is to identify and rectify any damage in good time in order to guarantee safe use of the formwork system.

Exceptional events could be:

- accidents,
- long periods of non-use,
- natural events, e.g. heavy rainfall, icing, heavy snowfall, storms or earthquakes.

Assembly, modification and dismantling work

Assembly, modification or dismantling of formwork or climbing systems may only be carried out by qualified persons under the supervision of a competent person. The qualified personnel must have received appropriate training for the work to be carried out with regard to specific risks and dangers.

On the basis of the risk assessment and Instructions for Assembly and Use, the contractor must create installation instructions, in order to ensure safe assembly, modification and dismantling of the formwork or climbing unit.



The contractor must ensure that the personal protective equipment required for the assembly, modification or dismantling of the climbing formwork, e.g.

- safety helmet,
- safety shoes,
- safety gloves,
- safety goggles,

is available and used as intended.



If personal protective equipment against falling from a height (PPE) is required or specified in local regulations, the contractor must determine appropriate attachment points on the basis of the risk assessment.

The PPE against falling to be used is determined by the contractor.

The contractor must

- provide safe working areas for site personnel, which are to be reached through the provision of safe access ways. Areas of risk must be cordoned off and clearly marked.
- ensure stability during all stages of construction, in particular during assembly, modification and dismantling operations.
- ensure and provide evidence that all loads that occur are transferred safely.

Use

Every contractor who uses or allows formwork or climbing systems to be used, is responsible for ensuring that the equipment is in good condition.

If the scaffolding or climbing system is used successively or at the same time by several contractors, the health and safety coordinator must point out any possible mutual hazards and all work must then be coordinated.

System-specific

Retract components only when the concrete has sufficiently hardened and the person in charge has given the go-ahead for striking to take place.

Anchoring

Anchoring is to take place only if the anchorage has sufficient concrete strength.

Concrete adhesive

Concrete adhesives can pose hazards. Observe the manufacturer's instructions for use and safety data sheets.

Installing DK and SK Concrete Cones

Tool for removing tie cones

Removing tie cones



Condition after striking.

- 50** Sealing cover
- 51** DK Sealing Cone or SK Tie Cone or MX Magnet Cone

Pos.	Anchoring	Pos.	Tools	Item no.
50.1	SK Sealing Cover UNI DW 15		Screwdriver	
50.2	SK Sealing Cover DW 20	50		
50.3	SK Sealing Cover DW 26			
51.1	DK Sealing Cone DW 15/35	52.1	DK Cone Spanner UNI	031655
51.2	DK Sealing Cone DW 15/55			
51.3	DK Sealing Cone DW 20/55			
51.4	DK Sealing Cone DW 26/55			
51.5	SK Tie Cone-2 DW 15	52.2	Socket SW 27 – 1/2" + ratchet wrench 1/2"	029650
51.6	SK Tie Cone DW 20	52.3	Socket Wrench SW 36	031480
51.7	SK Tie Cone DW 26	52.4	Socket SW 46 – 1" + ratchet wrench 1"	029630 029610
51.8	Magnet Cone MX 15	52.5	Magnet Cone Spanner MX 15 / MX 18	126696
51.9	Magnet Cone MX 18			

Tab. 01

1. If present: Lift and remove the sealing cover (**50**) with a screwdriver or similar tool. (Fig. 02 a)
2. Only in the case of magnet cones: Use the lug of the magnet cone spanner to remove concrete slurry promptly after striking. (Fig. 02b)

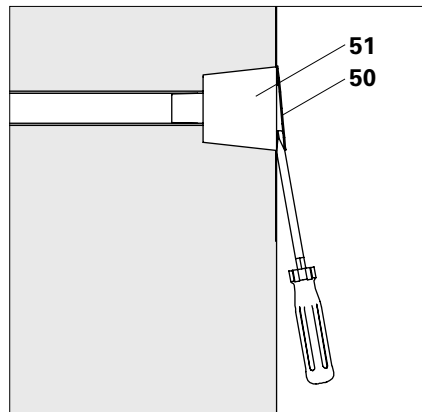

Fig. 02 a

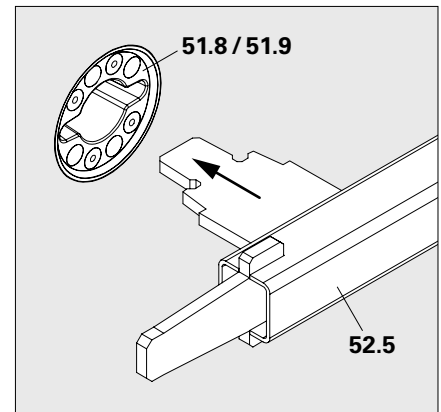

Fig. 02b

3. Unscrew cone (**51**) with the appropriate tool (**52**), see Tab. 01. (Fig. 03a/03b)

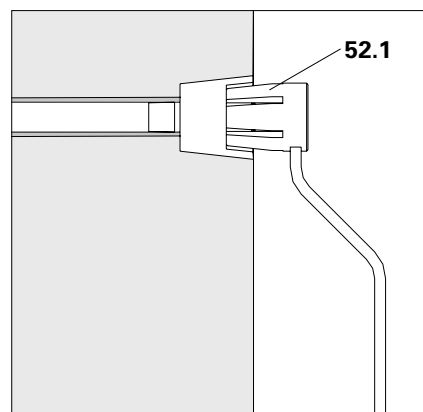

Fig. 03 a

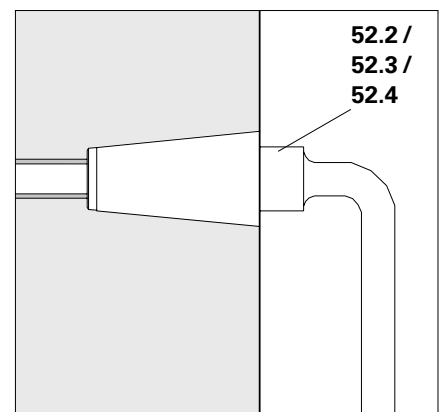

Fig. 03b

4. Clean the hole, e.g. with a brush.
(Fig. 04)

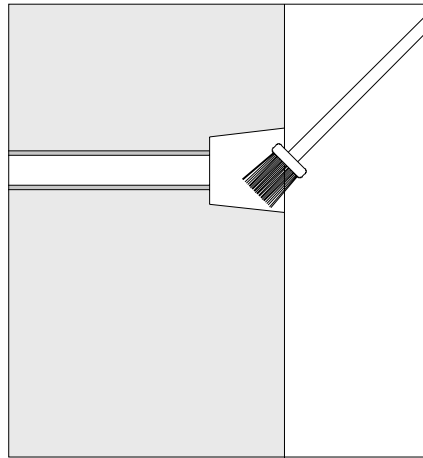

Fig. 04

Concrete adhesive



Warning

Concrete adhesives can pose hazards.
⇒ Observe the respective manufacturer's instructions for use and safety data sheets.



- Install the DK Concrete Cone DW 15-58/30, item. no. 031642 with Repoxal adhesive only, item. no. 031550.
- Install all other DK or SK Concrete Cones with Sealing Compound-3, item. no. 131709. Only every mix full tins.
- Select concrete adhesive, see also "System components" on page 3.

Installing concrete cones



- The surface of the cone openings must be dry and free of ice, grease and dust.
- Open the packing tub before fixing and allow the concrete cones to dry out.
- Ensure that the ambient temperature in the vicinity of the concrete adhesive conforms to the manufacturer's instructions.
- The specific requirements of the area of application, e.g. impermeable to water and gas, fire-resistant or radiation-resistant, must be checked by the customer to see whether the measures taken are sufficient.
- The tie points will only be tight if the concrete cones are glued in carefully.

Tools

53 DK or SK Cone Tongs (Tab. 02)

54 Gauge

Tongs for installing concrete cones

Pos.	Concrete cone	Pos.	Tools	Item no.
55.1	DK Concrete Cone DW 15-58/30	53.1	DK Cone Tongs 58	031644
55.2	DK Concrete Cone UNI 58/52			
55.3	DK Concrete Cone Architectural 02 UNI 58/32			
55.4	SK Concrete Cone DW 20 67/60	53.2	SK Cone Tongs 67	031656
55.5	SK Concrete Cone DW 20 100/60	53.3	SK Cone Tongs 100	031657

Tab.02

Components

- 55.1** DK Concrete Cone DW 15-58/30*
- 55.2** DK Concrete Cone UNI 58/52**
- 55.3** DK Concrete Cone Architectural 02 UNI 58/32
- 55.4** SK Concrete Cone DW 20-67/60
- 55.5** SK Concrete Cone DW 26-100/60
- 56** Sealing Compound-3
- 57** Repoxal adhesive



- Only ever mix full tins of Sealing Compound-3.
- The specific requirements for architectural concrete, e.g. adhesive residue, must be checked by the customer.

Preparation

Prepare concrete adhesive (**56 / 57**) according to the manufacturer's instructions.



Fig. 05

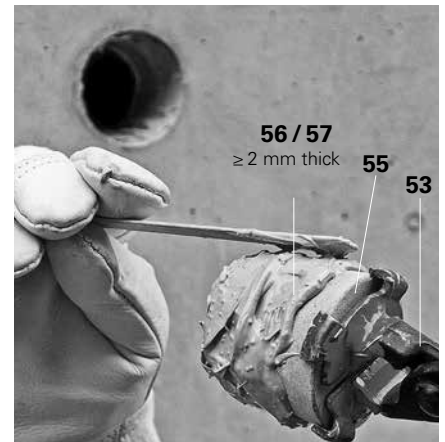

Fig. 06

Assembly

1. Apply a thin, even coat of concrete adhesive (**56 / 57**) to the cone opening. (Fig. 05)
2. Hold the dry concrete cone (**55**) with suitable cone tongs (**53**) and apply the prepared concrete adhesive (**56 / 57**) evenly to the sides and end faces, at least 2 mm thick. (Fig. 06)
3. Insert the concrete cone into the tie point and turn it slightly several times → The adhesive spreads out evenly. (Fig. 07)
4. Tap the concrete cone flush with the cone gauge (**54**). (Fig. 08)
5. Scrap the surplus adhesive off with a filling knife. (Fig. 09) → The tie point is clean and tightly closed.

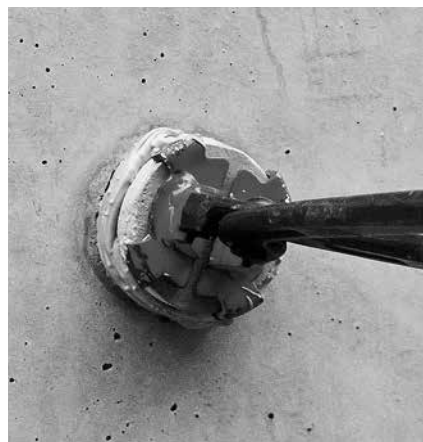

Fig. 07



Fig. 08



Fig. 09

Installing the SK Lead Cone



- Condition after striking.
- For the purposes of radiation optimisation, the tie rod without spacer tube is a lost component. The SK Lead Cone is installed in addition to the DK Concrete Cone.
- The specific requirements of the area of application, e.g. impermeable to water and gas, fire-resistant or radiation-resistant, must be checked by the customer to see whether the measures taken are sufficient.
- Tie Rod DW 15 for wall thickness ≥ 30 cm.
- Installed on both sides.

Components for removal

- 50** Sealing cover
- 51** DK Sealing Cone

Assembly aids

- 52.1** DK Cone Spanner UNI 031655
- 59** Steel tube
- 60** Hammer

Pos. Components	Item. no.
55.2 DK Concrete Cone UNI 58/52	031643
56 Sealing Compound-3	131709
61 SK Lead Cone	104643

Assembly

1. Remove tie cone (**51**) with DK Cone Spanner (**52.1**). (Fig. 11)
2. Lift off and remove the sealing cover (**50**). (not shown)
3. Insert the lead cone (**61**) into the recess. (Fig. 12)
4. Tap in the lead cone with steel tube (**59**) and hammer (**60**).
→ Lead cone is deformed to ~ 15 mm (Fig. 13)
5. Glue in the concrete cone, see "Installing concrete cones" on page 13 ff.
6. Repeat points 1 to 5 on the other side of the wall. (Fig. 11 to Fig. 14)

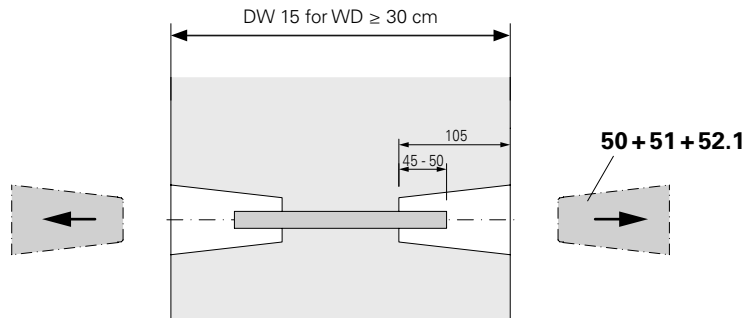

Fig. 11

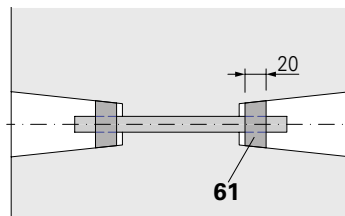

Fig. 12

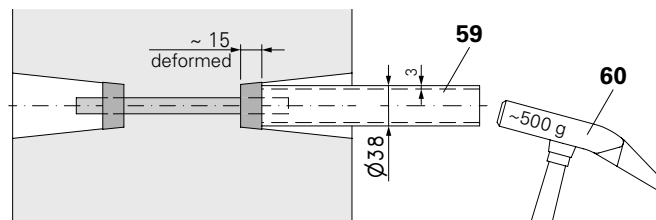

Fig. 13

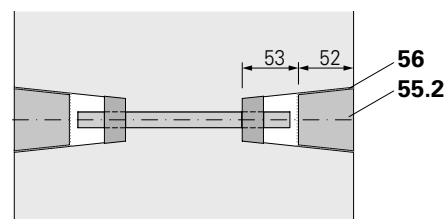

Fig. 14



- Tool for removing cones, see page 22 Fig. 23.
- Tool for installing concrete cones, see page 22 Fig. 23. (Tab. 02)
- Precise description for installing concrete cones, see page 22 Fig. 23.

Installing KK and SWLK Concrete Cones

- For architectural concrete or water-proof concrete, seal the tie holes of the KK Climbing Cones with KK Concrete Cones.
- The SWLK Concrete Cones are used to close the tie points of the Heavy-Duty Cone M36/DW26 – Ø108.



- The specific requirements of the area of application, e.g. impermeable to water and gas, fire-resistant or radiation-resistant, must be checked by the customer to see whether the measures taken are sufficient.
- Only ever use Sealing Compound-3 for KK Concrete Cones.
- The Sealing Compound-3 ensures an all-round uniform sealing joint when installing concrete cones. It prevents the concrete cone from setting.

Components for removal

- 62.1** Screw-On Cone M24
- 62.2** KK Climbing Cone M30
- 62.3** KK Climbing Cone M36
- 62.4** SWLK Heavy-Duty Cone M36/DW26-D108

Removing tie cones

1. Release the climbing cone (**62**) with a suitable tool, see Tab. 03.

Tool for removing climbing cones

Pos.	Tie cone	Pos.	Tools	Item no.
62.1	Screw-On Cone M 24	63.1	Socket Wrench SW 36	031480
62.2	Climbing Cone M 30	63.2	Socket AF 46 – 1" + ratchet wrench 1"	029630 029610
62.3	Climbing Cone M 36	63.3	12-point Wrench socket AF 55 – 1" + ratchet wrench 1"	029640 029610
62.4	Heavy-Duty Cone M 36	63.4	Recovering Tool AF 36 + ratchet wrench 1"	128601 029610

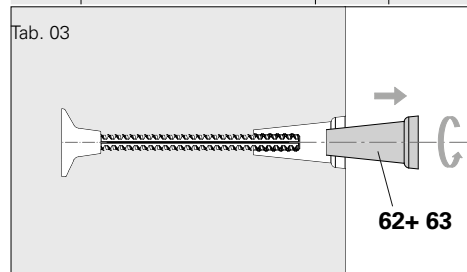

Fig. 15

2. Unscrew the climbing cone by hand and remove. (Fig. 15)

Concrete adhesive



Warning

Concrete adhesives can pose hazards.
⇒ Observe the manufacturer's instructions for use and safety data sheets.

Installing components

56 Sealing Compound-3

64.1 KK Concrete Cone M24-67/52

64.2 KK Concrete Cone M30-80/52

64.3 KK Concrete Cone M36-90/52

64.4 SWLK Concrete Cone M36-105/52

Preparation

Prepare the concrete adhesive (**56**) according to the manufacturer's instructions.

Assembly

1. Coat the outer surface of the KK Concrete Cone (**64**) with prepared concrete adhesive (**56**).
2. Insert the KK Concrete Cone into the tie hole by hand.
Cone tongs are not required for this.
→ The tie hole is closed.
(Fig. 16)

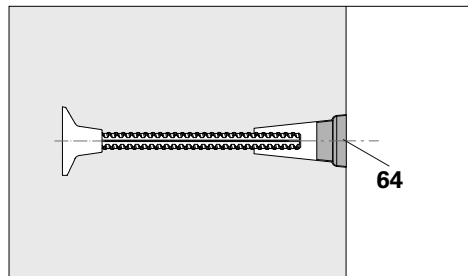

Fig. 16

Installing Plugs FRC



There are two sizes of tie hole and therefore also two Plugs FRC.

- Ø 32 for fibre cement pipe – lost component. (Fig. 17 a)
- Ø 40 for threaded cone. (Fig. 17b)
- Remove add-on parts
- Install Plugs FRC with Repoxal adhesive only.

Pos Installation components

Item no.

57	Repoxal adhesive	031550
67.1	Plug FRC Ø 32	116234
67.2	Plug FRC Ø 40	123820

Concrete adhesive



Warning

Concrete adhesives can pose hazards.
⇒ Observe the manufacturer's instructions for use and safety data sheets.

Preparation

Prepare the concrete adhesive (**57**) according to the manufacturer's instructions.

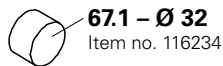

Fig. 17 a



Fig. 17b

Seal tie hole for Plug FRC Ø 32

1. Clean tie hole.
2. Apply the prepared Repoxal adhesive to the front and side surface of the Plug FRC Ø32 (**67.1**). (Fig. 18 a)
3. Insert the Plug FRC into the opening and tap it into the tie hole with a rubber mallet until it is flush. (Fig. 18b)
4. Remove adhesive residue with a spatula. (not shown)

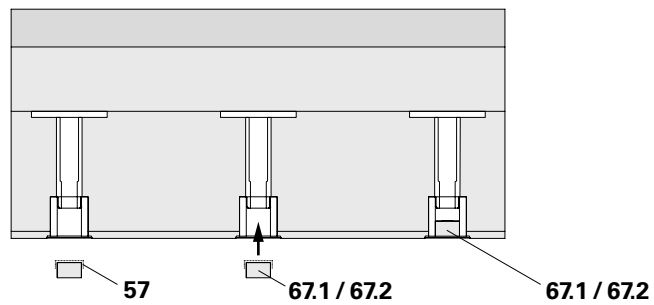

Fig. 18 a

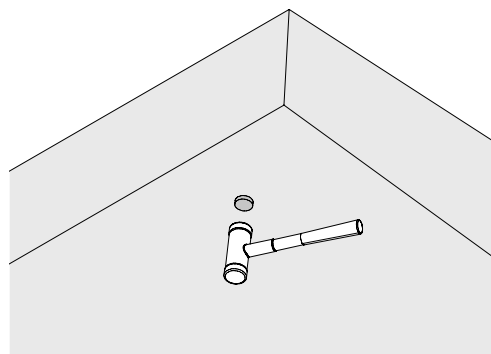

Fig. 18b

Seal tie hole for Plug FRC Ø 40

1. Remove threaded cone.
2. Clean tie hole.
3. Apply the prepared concrete adhesive (**57**) to the front and side surface of the Plug FRC Ø40 (**67.2**).
4. Insert the Plug FRC into the opening and tap it into the tie hole with a rubber mallet until it is flush.
5. Remove adhesive residue with a spatula. (not shown)

Closing the tie hole



- The Plug FC MX 15 1/50 and Plug FC MX 15 2/50 are tested for water impermeability.
- The specific requirements of the area of application, e.g. impermeable to water and gas, fire-resistant or radiation-resistant, must be checked by the customer to see whether the measures taken are sufficient.
- Observe the following during installation:
 - Conical tie hole
 - Different diameters of plugs
 - FC MX 15 1/50 or 2/50
 - FC MX 18 3/50 or 4/50
 - Installation position of the plugs
 - MXM 15 Ø 18.3 – dimension 51
 - MX 18 Ø 24-28 – dimension 51
- The specific requirements for architectural concrete must be checked by the customer.
- Install Plugs FC MX with Repoxal adhesive only.

Tools for installation of the components

68	Threaded rod M 12	1x
69	Nut M 12	1x
70	Washer	1x

Components to be installed

57	Repoal adhesive	1x
	Item no. 031550	
71a	Plug MXM 15 Ø 18.3	2x
	Item no. 124895	
71b	Plug MX 18 Ø 24-28	2x
	Item no. 125300	
72	Plug FC MX 15 1/50	1x
	Item no. 126699	
73	Plug FC MX 15 2/50	1x
	Item no. 126700	
74	Plug FC MX 18 3/50	1x
	Item no. 136737	
75	Plug FC MX 18 4/50	1x
	Item no. 136738	

Concrete adhesive



Warning

Concrete adhesives can pose hazards.
 ⇒ Observe the manufacturer's instructions for use and safety data sheets.

Preparation

Prepare the concrete adhesive (**57**) according to the manufacturer's instructions.

Assembly

1. Insert the threaded rod into the plug (**71a / 71b**) and adjust to dimension "x" with the threaded rod (**68**), nut (**69**) and washer (**70**). (Fig. 19 a)
2. Push the threaded rod with plug into the tie hole from the larger diameter of the tie hole until the washer hits the edge of the concrete.
→ There are 51 mm remaining on the other side. (Fig. 19b)
3. Coat Plug 1/50 or 3/50 (**72 / 74**) on one face and the outer surface with ready-made Repoxal adhesive (**57**) and push it into the tie hole from the smaller side of the tie hole. Make sure that the adhesive-coated end face is pushed onto the flat surface of the plug. (Fig. 20)
4. Insert the threaded rod (**68**) into the plug (**71a / 71b**) and adjust to dimension "51" with the threaded rod (**68**), washer (**70**) and nut (**69**). (Fig. 21 a)
5. Push the plug (**71a / 71b**) into the larger side of the tie hole with the threaded rod against the flat surface of the plug. (Fig. 21b)
6. Apply ready-to-use concrete adhesive (**57**) to one face and the outer surface of Plug 2/50 or 4/50 (**73 / 75**) and push them into the tie hole. Make sure that the adhesive-coated end face is pushed onto the flat surface of the plug. (Fig. 22a + 22b)
7. If necessary, fill the existing recess – on both sides – with adhesive and smooth it down. (not shown)

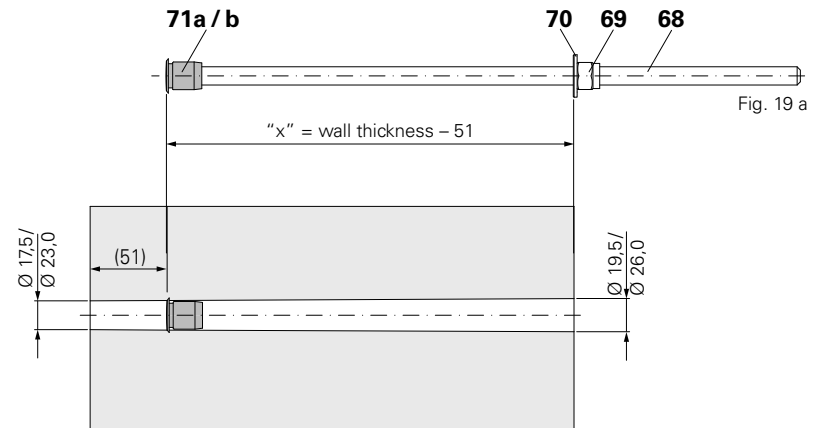

Fig. 19 a

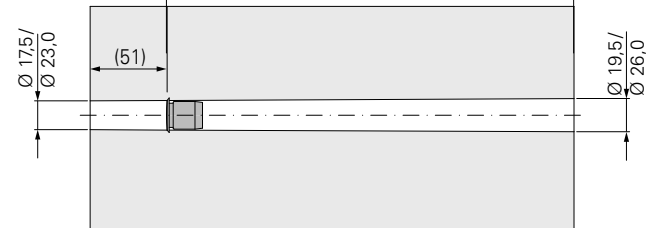

Fig. 19b

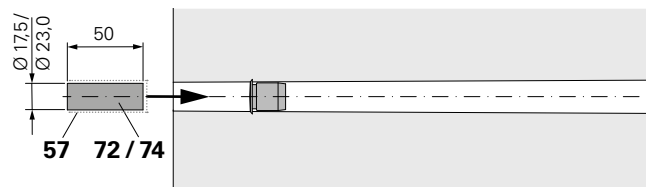

Fig. 20

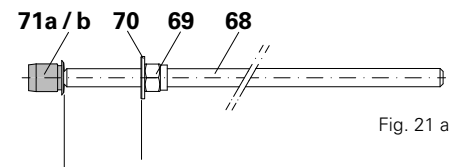

Fig. 21 a

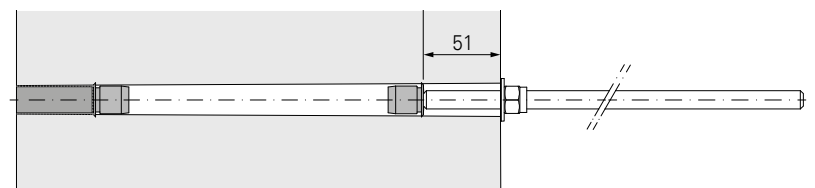

Fig. 21b

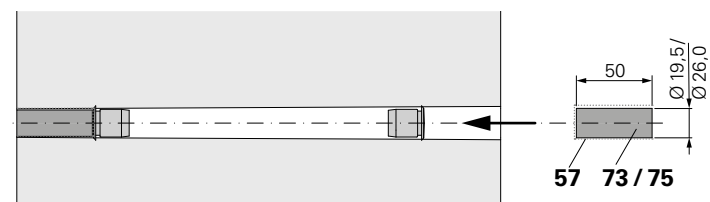

Fig. 22 a

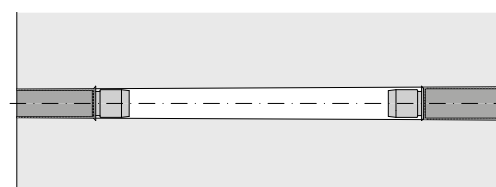

Fig. 22b

Closing the tie hole



The specific requirements of the area of application, e.g. impermeable to water and gas, fire-resistant or radiation-resistant, must be checked by the customer to see whether the measures taken are sufficient.

Components to be installed

56	Repoxal adhesive	1x
	Item no. 031550	
76	Plug FRC Ø 22	2x
	Item no. 031360	



Fig. 23

Concrete adhesive



Warning

Concrete adhesives can pose hazards.
⇒ Observe the manufacturer's instructions for use and safety data sheets.

Preparation

Prepare the concrete adhesive (**57**) according to the manufacturer's instructions.

Assembly

1. Coat the plug (**76**) with prepared concrete adhesive (**57**).
2. Insert the plug into the tie hole.
(Fig. 23)

Item no.	Weight kg		
031642	0.152	<p>DK Concrete Cone DW 15-58/30</p> <p>For closing tie DK Sealing Cone DW 15/35, DW 15/55, DW 20/55, DW 26/55, SK Tie Cone DW 15, Magnet Cone MX 15 - 55, Magnet Cone MX 18 - 55, Arch. Leading Cone M24.</p>	<p>Note</p> <p>Delivery unit: 50 pieces.</p>
031635	0.043	<p>DK Sealing Cone DW 15/35</p> <p>For fire-resistant and sound-absorbing tie points with DW 15. Resistant to seepage water. Use with Rough Tube 22.</p>	<p>Note</p> <p>Delivery unit: 50 pieces.</p>
031639	0.006	<p>SK Sealing Cover UNI DW 15</p> <p>For sealing the DK Sealing Cones DW 15 and SK Tie Cones DW 15 on the formwork side.</p>	<p>Note</p> <p>Delivery unit: 50 pieces.</p> <p>When using the SK Sealing Cover with SK Tie Cone, the tie rod must be shortened by 1 mm at each end.</p>
112937	0.173	<p>Magnet Cone MX 15</p> <p>For use with MAXIMO. For use with Tie MX.</p>	<p>Note</p> <p>For use with waterproof or architectural concrete.</p>
		<p>Accessories</p>	
126696	1.220	<p>Magnet Cone Spanner MX 15 / MX 18</p>	

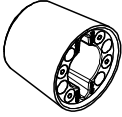
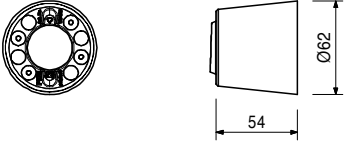
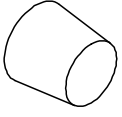
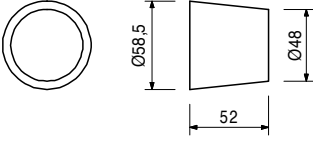
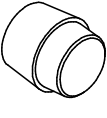
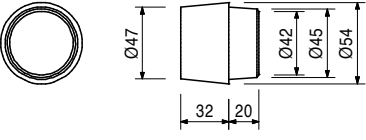
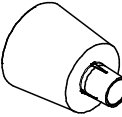
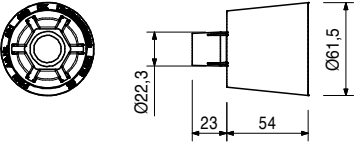
Item no.	Weight kg		
127425	0.160	Magnet Cone MX 18 For use with MAXIMO. For use with Tie MX.	Note For use with waterproof or architectural concrete.
			
Accessories			
126696	1.220	Magnet Cone Spanner MX 15 / MX 18	
031643	0.225	DK Concrete Cone UNI 58/52 For closing tie /anchor points with DK Sealing Cone DW 15/55, DW 20/55, DW 26/55, SK Tie /Anchor Cone DW 15, Magnet Cone MX 15 - 55, Magnet Cone MX 18 - 55, Arch. Leading Cone M24.	Note Delivery unit: 50 pieces.
			
132972	0.206	DK Concrete Cone Architectural/02 DW 15-58/52 For closing tie points with DK Sealing Cone DW 15/55, DW 20/55, DW 26/55, SK Tie Cone DW 15, Magnet Cone MX 15 - 55, Magnet Cone MX 18 - 55, Arch. Leading Cone M24 with the corresponding architectural requirements.	Note Replacement for item no. 031641
			
031636	0.063	DK Sealing Cone DW 15/55 For waterproof, fire-resistant and sound-absorbing tie points with Tie Rods DW 15. Use with Spacer Tube rough 22.	Note Delivery unit: 50 pieces.
			

Item no.	Weight kg
126609	0.593

SK Tie Cone DW 15/2

For waterproof, fire-resistant, sound-absorbing and radiation-proof tie points with Tie Rods DW 15. Suitable for strongrooms.

Technical data

Permissible tension force 90 kN.
Tie rod length = wall thickness - 2 x 55 mm

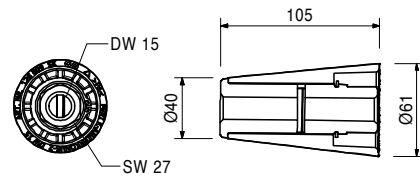
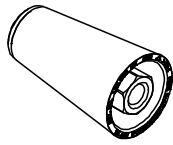

031639	0.006
--------	-------

SK Sealing Cover UNI DW 15

For sealing the DK Sealing Cones DW 15 and SK Tie Cones DW 15 on the formwork side.

Note

Delivery unit: 50 pieces.
When using the SK Sealing Cover with SK Tie Cone, the tie rod must be shortened by 1 mm at each end.

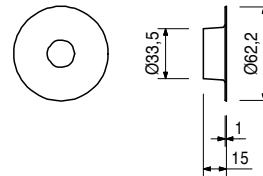

031637	0.055
--------	-------

DK Sealing Cone DW 20/55

For waterproof, fire-resistant and sound-absorbing tie points with Tie Rods DW 20. Use with Spacer Tube rough 28.

Note

Delivery unit: 50 pieces.

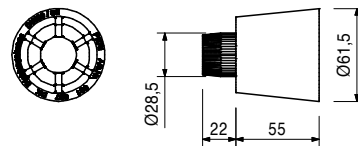
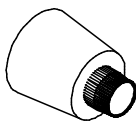

031638	0.054
--------	-------

DK Sealing Cone DW 26/55

For waterproof, fire-resistant and sound-absorbing tie points with Tie Rod DW 26. For use with Spacer Tube rough 42.

Note

Delivery unit: 50 pieces.

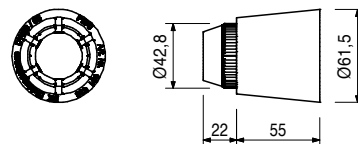
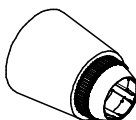

Item no.	Weight kg
112937	0.173

Magnet Cone MX 15
 For use with MAXIMO.
 For use with Tie MX.

Note
 For use with waterproof or architectural concrete.

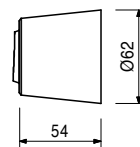
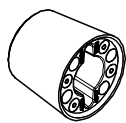

126696	1.220
--------	-------

Accessories
Magnet Cone Spanner MX 15 / MX 18

127425	0.160
--------	-------

Magnet Cone MX 18
 For use with MAXIMO.
 For use with Tie MX.

Note
 For use with waterproof or architectural concrete.

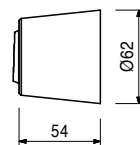
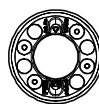
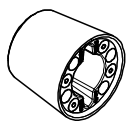

126696	1.220
--------	-------

Accessories
Magnet Cone Spanner MX 15 / MX 18

031650	0.364
--------	-------

SK Concrete Cone DW 20-67/60
 For closing tie points with SK Tie Cone DW 20.

Note
 Delivery unit: 50 pieces.

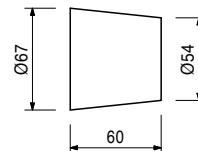
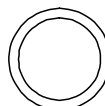
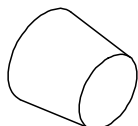

031646	1.030
--------	-------

SK Tie Cone DW 20
 For waterproof, fire-resistant, sound-absorbing and radiation-proof tie points with Tie Rods DW 20.
 Suitable for strongrooms.

Technical data
 Permissible tension force 150 kN.
 Tie rod length = wall thickness - 2 x 65 mm

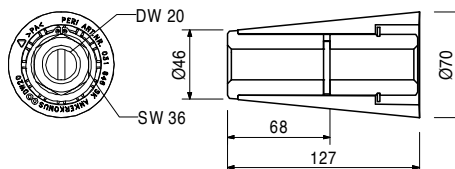
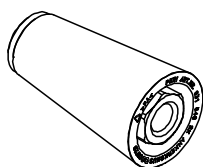

Item no.	Weight kg
031648	0.008

SK Sealing Cover DW 20

For sealing the SK Tie Cone DW 20 on the form-work side.

Note

Delivery unit: 50 pieces.
When using the SK Sealing Cover with SK Tie Cone, the tie rod must be shortened by 1.5 mm at each end.

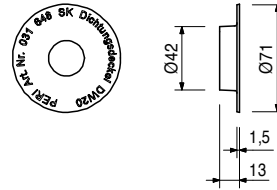

031651	0.801
--------	-------

SK Concrete Cone DW 26 -100/60

For closing tie points with SK Tie Cone DW 26.

Note

Delivery unit: 50 pieces.

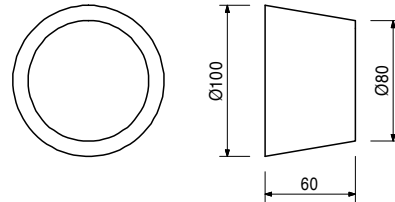
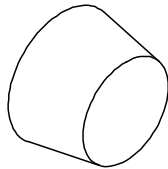

031647	1.920
--------	-------

SK Tie Cone DW 26

For waterproof, fire-resistant, sound-absorbing and radiation-proof tie points with Tie Rods DW 26. Suitable for strongrooms.

Technical data

Permissible tension force 250 kN.
Tie rod length = wall thickness – 2 x 75 mm

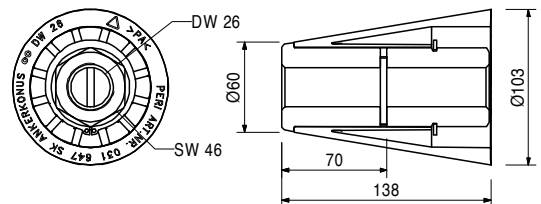
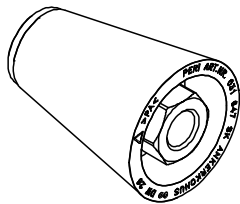

031649	0.014
--------	-------

SK Sealing Cover DW 26

For sealing the SK Tie Cone DW 26 on the form-work side.

Note

Delivery unit: 50 pieces.
When using the SK Sealing Cover with SK Tie Cone, the tie rod must be shortened by 2 mm at each end.

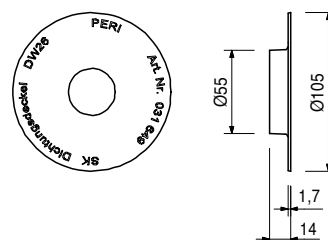

Item no.	Weight kg
104643	0.260

SK Lead Cone DW 15

Also for closing the tie points of SK Tie Cone DW 15 in radiation-proof rooms.

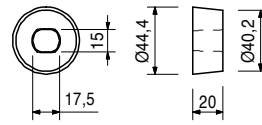

126609	0.593
--------	-------

SK Tie Cone DW 15/2

For waterproof, fire-resistant, sound-absorbing and radiation-proof tie points with Tie Rods DW 15. Suitable for strongrooms.

Technical data

Permissible tension force 90 kN.
Tie rod length = wall thickness - 2 x 55 mm

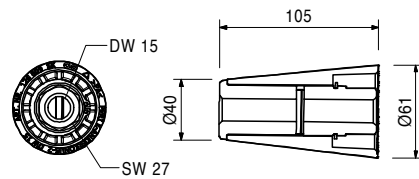
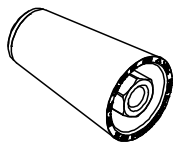

031652	0.247
--------	-------

KK Concrete Cone M24-67/52

For closing tie points with Climbing Cone-2 M24/DW 15 and Screw-On Cone-2 M24/DW 20.

Note

Delivery unit: 50 pieces.

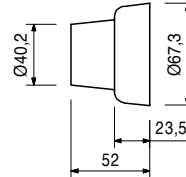
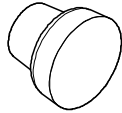

031220	1.010
--------	-------

Climbing Cone-2 M24/DW 15, galv.

Anchor System M24.
For anchoring climbing systems.

Note

Separate design information on request.

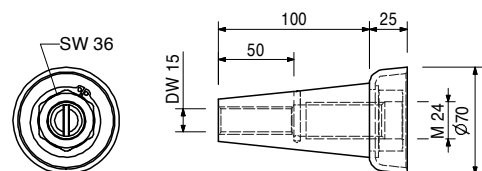
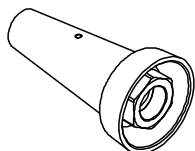

Accessories

030840	0.515
030030	1.440
030740	1.550

Threaded Anchor Plate DW 15
Tie Rod DW 15, special length
Tie Rod B 15, special length

Item no.	Weight kg
114158	1.030

Screw-On Cone-2 M24/DW 20, galv.
Anchor System M24.
For anchoring climbing systems.

Note
Separate design information on request.

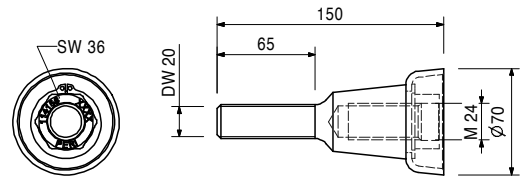
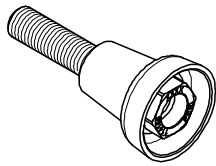

Item no.	Weight kg
030860	0.792

Accessories
Threaded Anchor Plate DW 20

031653	0.364
--------	-------

KK Concreting Cone M30-80/52
For closing tie points with Climbing Cone-2 M30/
DW 20 or Screw-On Cone M30/DW 26

Note
Delivery unit: 50 pieces.

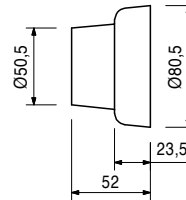
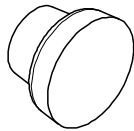

031654	0.512
--------	-------

KK Concrete Cone M36-90/52
For closing tie points with Climbing Cone-2 M36/
DW 26.

Note
Delivery unit: 50 pieces.

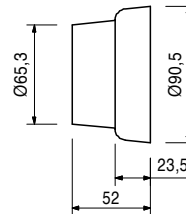
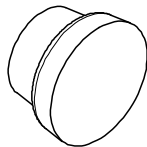

029480	1.830
--------	-------

Mounting Ring M30, galv.
Anchor System M30.
For anchoring climbing systems.

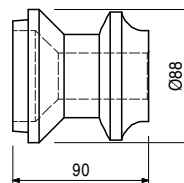
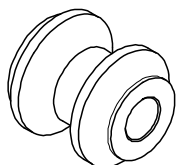

Item no.	Weight kg
029540	0.920

Accessories
Bolt ISO 4014 M30 x 130-10.9, galv.

Item no.	Weight kg
029490	1.760

Mounting Ring M36, galv.
Anchor System M36.
For anchoring climbing systems.

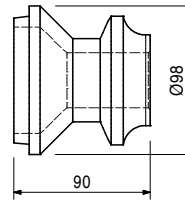
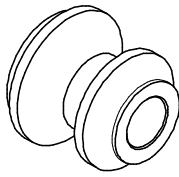

029550	1.400
--------	-------

Accessories
Bolt ISO 4014 M36 x 130-10.9, galv.

031645	0.593
--------	-------

SK Tie Cone DW 15
For waterproof, fire-resistant, sound-absorbing and radiation-proof tie points with Tie Rods DW 15.
Suitable for strongrooms.

Note
Wrench size SW 27.
Technical data
Permissible tensile force according to DIN 18216: 90 kN.
Tie rod length = wall thickness – 2 x 55 mm

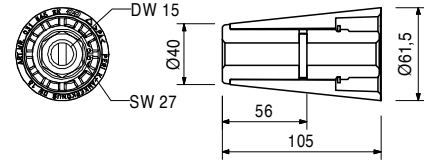
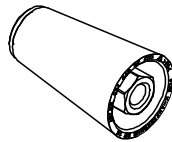

031646	1.030
--------	-------

SK Tie Cone DW 20
For waterproof, fire-resistant, sound-absorbing and radiation-proof tie points with Tie Rods DW 20.
Suitable for strongrooms.

Technical data
Permissible tension force 150 kN.
Tie rod length = wall thickness – 2 x 65 mm

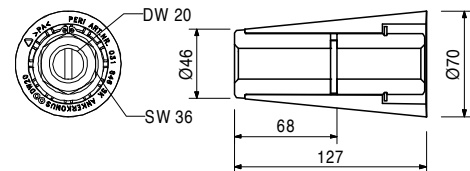
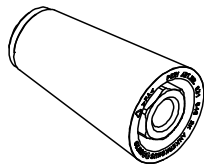

031647	1.920
--------	-------

SK Tie Cone DW 26
For waterproof, fire-resistant, sound-absorbing and radiation-proof tie points with Tie Rods DW 26.
Suitable for strongrooms.

Technical data
Permissible tension force 250 kN.
Tie rod length = wall thickness – 2 x 75 mm

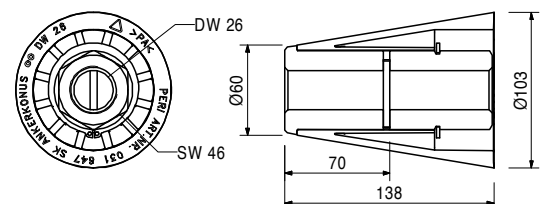
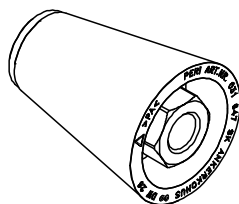

Item no. Weight kg

136576 0.838

SWLK Concrete Cone M36-105/52

For closing tie points with Heavy-Duty Cone M36/
DW26 – Ø108.

Note

Delivery unit: 10 pieces

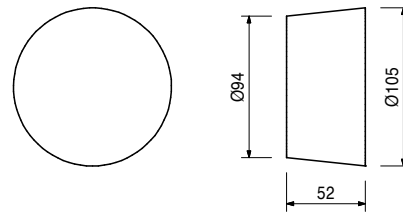
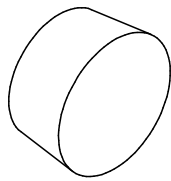

128536 5.870

Heavy-Duty Cone M36/DW 26 - Ø108

For transferring loads from high shear and tensile
forces into reinforced concrete.

Technical data

Load-bearing capacity according to expert's report
(on request)!

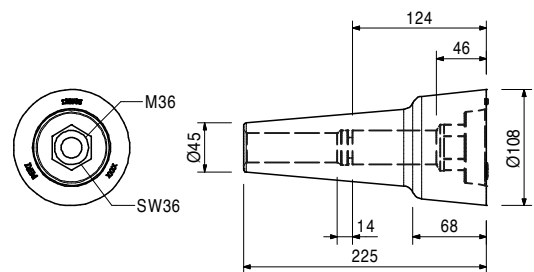
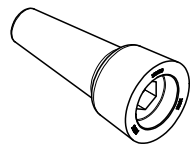

116234 0.033

Plug FRC Ø32

For closing the FRC Tube Ø32 mm.
Made of fibre-reinforced concrete.

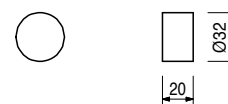

026230 1.010

Tie Sleeve M24

For anchoring of platform systems.

Note

Separate design information on request.

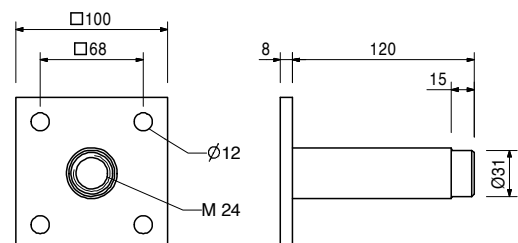
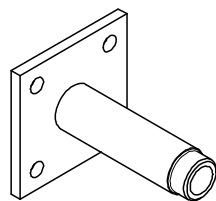

Accessories

026240	0.026	Spacer PP Ø31/26, c = 25
026250	0.005	Plug PP Ø26 mm
116233	0.116	Tube FRC Ø32/52, c = 40
026420	0.123	Anchor Positioning Stud M24, galv.
116234	0.033	Plug FRC Ø32
115150	0.200	Anchor Positioning Stud M24 x 65, galv.
123800	0.045	Threaded cone M24

Item no. Weight kg

116233 0.116

Tube FRC Ø32/52, c = 40

Results in concrete cover of 40 mm in combination with Tie Sleeve M24. Made of fibre-reinforced concrete.

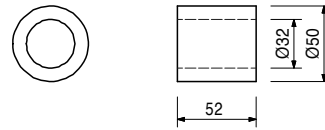
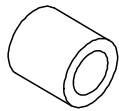

115150 0.200

Anchor Positioning Stud M24 x 65, galv.

For fixing Tie Sleeve M24 if the formlining cannot be drilled.

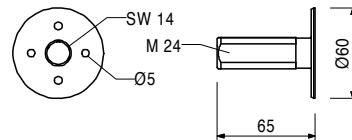
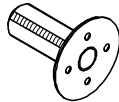

123820 0.060

Plug FRC Ø 40

For closing the tie hole when using the Threaded Cone M24.

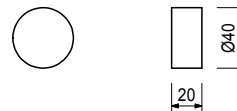

026230 1.010

Tie Sleeve M24

For anchoring of platform systems.

Note

Separate design information on request.

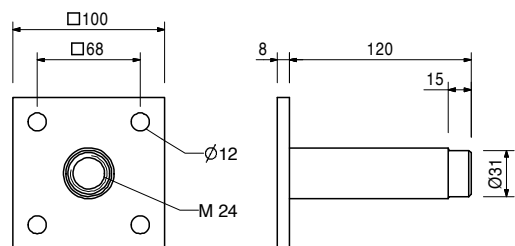
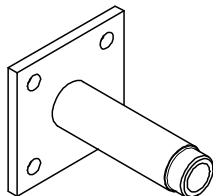

Accessories

026240 0.026

Spacer PP Ø31/26, c = 25

026250 0.005

Plug PP Ø26 mm

116233 0.116

Tube FRC Ø32/52, c = 40

026420 0.123

Anchor Positioning Stud M24, galv.

116234 0.033

Plug FRC Ø32

115150 0.200

Anchor Positioning Stud M24 x 65, galv.

123800 0.045

Threaded cone M24

Item no.	Weight kg
123800	0.045

Threaded cone M24

For advanced mounting of the Tie Sleeve M24 with 40 mm concrete cover in bridge cantilevers.

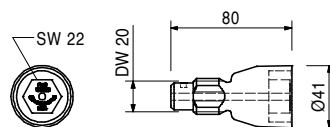
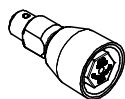

026230	1.010
123820	0.060
129157	0.017

Accessories

Tie Sleeve M24

Plug FRC Ø 40

Wire Nail 4.6 x 130

129157	0.017
--------	-------

Wire Nail 4.6 x 130

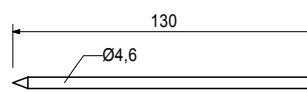
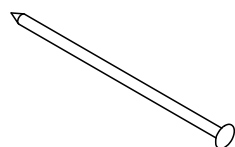

126699	0.028
--------	-------

Plug FC MX 15 1/50

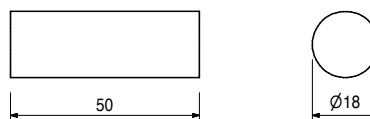
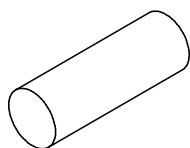

126700	0.033
--------	-------

Plug FC MX 15 2/50

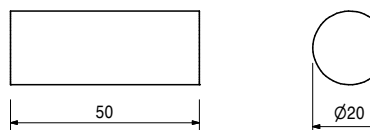
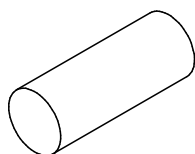

113847	4.030
--------	-------

Tie MX15, 15 – 25

For wall thicknesses of 15 – 25 cm.

Note

To make striking easier, spray with a release agent before every use.

Technical data

Permissible tension force 90 kN.

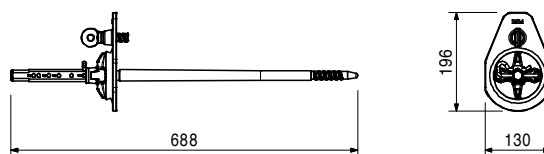
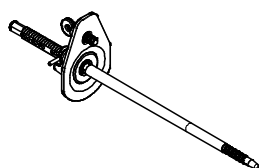

Item no.	Weight kg
112387	4.170

Tie MX15, 20 – 30
For wall thicknesses of 20 – 30 cm.

Note
To make striking easier, spray with a release agent before every use.

Technical data
Permissible tension force 90 kN.

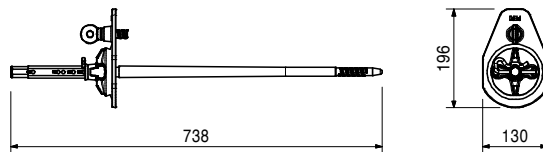
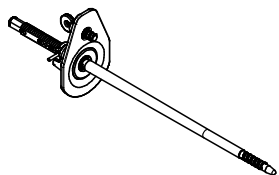

112464	4.430
--------	-------

Tie MX15, 30 – 40
For wall thicknesses of 30 – 40 cm.

Note
To make striking easier, spray with a release agent before every use.

Technical data
Permissible tension force 90 kN.

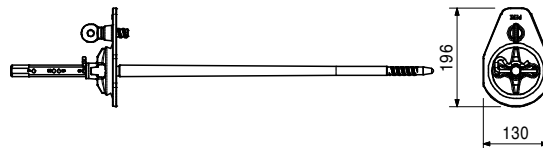
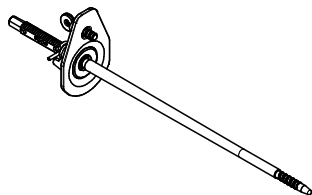

136737	0.052
--------	-------

Plug FC MX 18 3/50

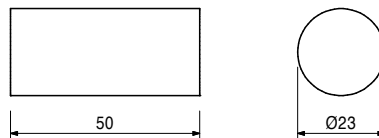
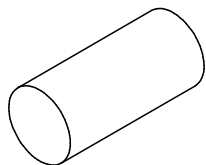

136738	0.066
--------	-------

Plug FC MX 18 4/50

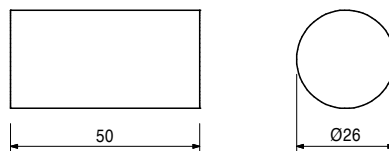
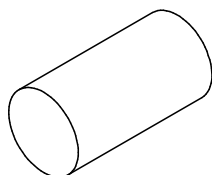

Item no.	Weight kg
123901	4.880

Tie MX 18, 15 – 25
For wall thicknesses of 15 – 25 cm.

Note
To make striking easier, spray with a release agent before every use.

Technical data
Permissible tension force 130 kN.

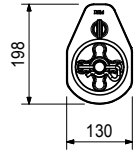
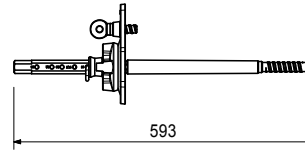
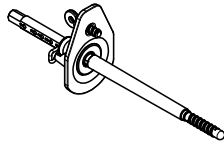

123902	5.080
--------	-------

Tie MX 18, 20 – 30
For wall thicknesses of 20 – 30 cm.

Note
To make striking easier, spray with a release agent before every use.

Technical data
Permissible tension force 130 kN.

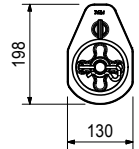
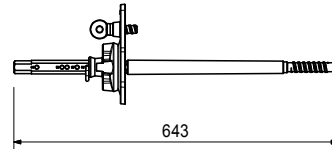
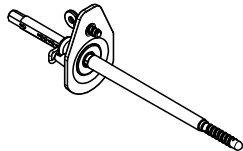

123903	5.490
--------	-------

Tie MX 18, 30 – 40
For wall thicknesses of 30 – 40 cm.

Note
To make striking easier, spray with a release agent before every use.

Technical data
Permissible tension force 130 kN.

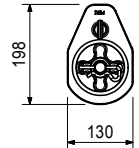
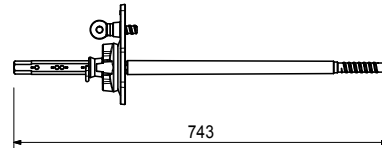
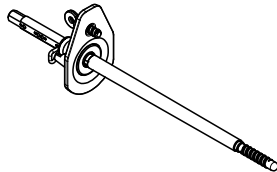

123904	5.900
--------	-------

Tie MX 18, 40 – 50
For wall thicknesses of 40 – 50 cm.

Note
To make striking easier, spray with a release agent before every use.

Technical data
Permissible tension force 130 kN.

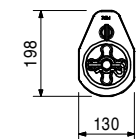
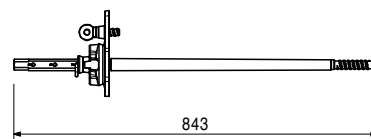
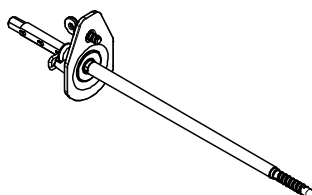

Item no.	Weight kg
123905	6.310

Tie MX 18, 50 – 60
For wall thicknesses of 50 – 60 cm.

Note
To make striking easier, spray with a release agent before every use.

Technical data
Permissible tension force 130 kN.

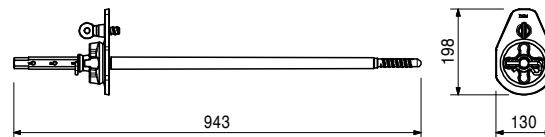
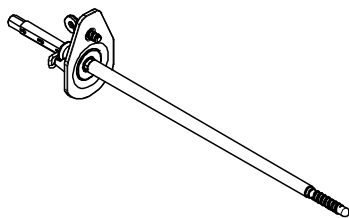

031360	0.017
--------	-------

Plug FCP 22
Made of fibre cement. Suitable for FCP 22.

Note
Delivery unit: 1000 pieces

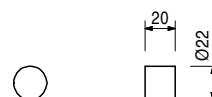

065033	0.010
--------	-------

Cone DR 22
Made of plastic. Suitable for Spacer Tube DR 22.

Note
Delivery unit: 500 pieces

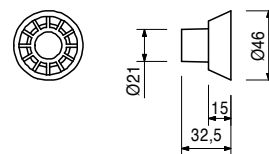

031260	1.500
--------	-------

Fibre Cement Pipe FCP 22, L = 0.90 m
Fibre cement spacer tube for DW 15, wall thickness 9 mm B 15. Asbestos-free!

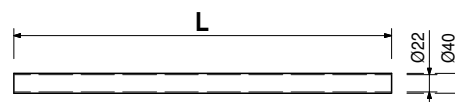
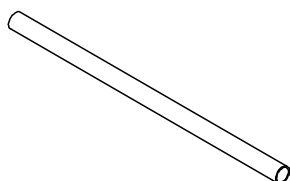

031390	0.005
--------	-------

Cone FCP 22
Suitable for FCP 22.

Note
Delivery unit: 1000 pieces

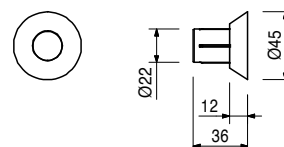

Item no.	Weight kg		
131709	9.980	Sealing Compound-3, 6-tin set For gluing PERI Concrete Cones in place.	Complete with 6 pcs. 131710 Sealing Compound-3 tin KO-A 6 pcs. 131711 Sealing Compound-3 tin KO-B Note Observe safety data sheet. Consisting of: 6 x component A, 6 x component B

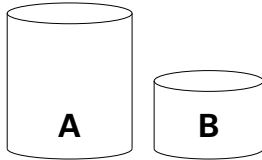

131710	0.890	Sealing Compound-3 tin KO-A	
--------	-------	------------------------------------	--

131711	0.670	Sealing Compound-3 tin KO-B	
--------	-------	------------------------------------	--

031550	1.000	Repoaxal adhesive, 2 components, 1 kg 2-component adhesive for bonding fibre cement plugs. Consumption: 1 kg adhesive for approx. 200 Plugs FCP 32 or 330 Plugs FCP 22.	Note Observe safety data sheet. Delivery unit: 1.0 kg
--------	-------	---	--

**The optimal System
for every Project and
every Requirement**



Wall Formwork



Column Formwork



Slab Formwork



Climbing Systems



Bridge Formwork



Tunnel Formwork



Shoring Systems



Construction Scaffold



Facade Scaffold



Industrial Scaffold



Access



Protection Scaffold



Safety Systems



**System-Independent
Accessories**



Services



PERI GmbH
Formwork Scaffolding Engineering
 Rudolf-Diesel-Strasse 19
 89264 Weissenhorn
 Germany
 Tel. +49 (0)7309.950-0
 Fax +49 (0)7309.951-0
 info@peri.com
 www.peri.com

